

Badrum Tillbehör

Svängbar utloppspip 150 mm

Artikelnummer: 480760000
Ytbehandling: Krom
Serie: Badrum Tillbehör

RSK nummer: 8141053
EAN nummer: 5708516337140

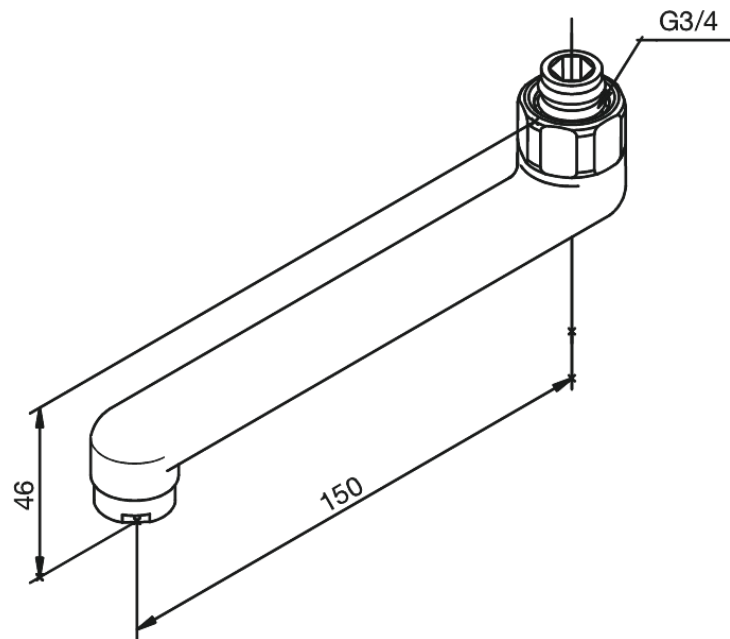

FM Mattsson AB
Box 480, SE-792 27 Mora

Tel.: 0250-59 64 50 kundservice@fmmattssongroup.com

För mer information besök <https://damixa.se>

damixa